

Magnetic and Conductivity Surveys

at Structures 163 and 165

26 November 2001

prepared for: Eric Deetz  
Jamestown Rediscovery  
1367 Colonial Parkway  
Jamestown, VA 23081

by: Bruce Bevan  
Geosight  
356 Waddy Drive  
Weems, Virginia 22576

Blue text in the digital version of this report marks hyperlinks to the figures at the end.

## Magnetic and Conductivity Surveys at Structures 163 and 165

The conductivity survey was done within the domed shelter over structure 163, in the area shown in [Figure 1](#). The filled-in trench of the early fort was found to have a much lower electrical conductivity than the surrounding soil. In [Figure 2](#), areas of low conductivity are indicated with a stippled pattern. A band of low conductivity extends to the northeast; while this geophysical anomaly is clear, its direction is perpendicular to the direction of the known trench. Two isolated areas of low conductivity were detected to the southeast; if the remnants of the trench are thin or fragmentary below structure 163, it is possible that these low conductivity anomalies could mark an extension of the trench.

The conductivity survey detected the iron rod at the south end of the area; this rod was also visible at the surface. It is likely that another metallic object has been detected by the conductivity survey; it is marked with an asterisk near the middle right side of [Figure 2](#). No cause for this anomaly was visible at the surface.

Magnetic measurements were made on the surfaces of 214 bricks within structures 163 and 165. The measurements in structure 163 found no evidence that this structure had been refired after the bricks were emplaced at their present locations. This was also true for the tests that were made on the bottoms of two fireplaces within structure 165. This surprising result simply means that these bricks were never heated enough to be fully-remagnetized by the fires in those fireplaces. More careful tests will be needed to determine if the outer surfaces of the bricks were remagnetized, even though the interiors were not.

The bricks that have fallen from the northern chimney of structure 163 were much more magnetic than the bricks at any of the other locations that were tested.

### The Site

These experiments were done on Jamestown Island, Virginia, on the historical site that is being investigated by the Association for the Protection of Virginia Antiquities. The coordinate of this location is W37° 12.73' N76° 47.19'.

The area is undergoing excavation by Jamestown Rediscovery, and this work is directed by William Kelso. These excavations have unearthed the foundations and foundation trenches of an early building, called structure 163. This excavation is inactive at this time, and it is covered by a large elliptical dome, 50 by 65 ft in size. The dome is framed with aluminum struts that form cells that are 10 - 20 ft on a side; this frame is covered by a tough impermeable fabric. Fans at the top of the dome provide ventilation. This dome has been in place for perhaps over two years. While the soil surface is quite dry; there is no visible evidence of efflorescence of salt. However, a test of the electrical resistivity of a sample of subsoil from this excavation found a very low reading (12 ohm-m = 83 mS/m), typical of soil that is saline.

The area of this survey is sketched in [Figure 1](#); features in this figure are not as detailed or accurate as those in the excavation map of the site. The southeast corner of a

large 17th-century building has been exposed by excavation; this building was about 50 ft long. The foundations are stone cobbles, and there were two large fireplaces on the western side. The chimneys have fallen to the east, and much of the interior of the structure is covered by brick rubble from those chimneys; not all of the brick concentrations are shown in [Figure 1](#). The site map shows the locations of some isolated bricks, and the mapped bricks in one magnetic test area are also plotted in [Figure 1](#).

Magnetic measurements were made on the bricks in two areas shown in [Figure 1](#). The numbered bricks locate the first area. The second area was at the southwest corner of the southern fireplace; the bricks at this location may have a different size from the others, and it is possible that many of these could have been imported to the site. The third area of magnetic test in structure 163 was just to the north of the area in [Figure 1](#), where the bricks from the northern chimney had fallen. While bricks in this area appear to be just a random jumble, close examination reveals that the relative locations and orientations of bricks remain roughly the same as they had in the standing chimney. Almost none of the bricks have been disturbed by excavation, for their bottoms are still firmly attached to the soil matrix. Magnetic measurements were made only on bricks that appear never to have been moved since their burial.

A trench that went around the palisade of the early fort extends into the survey area; it is marked with a stippled band in [Figure 1](#). The fill soil of this trench is visible by its lighter color, both on the top of the excavated surface and also on the vertical face of the excavation into the foundation trench for structure 163. The fort's trench at this location is about 4 ft wide and roughly 2 ft deep. This trench probably continues below structure 163, but the excavations are not yet deep enough there to reveal it.

Charred timbers are visible near E9790 N9716, just east of the southern fireplace. Except for this and the brick jumbles, the excavated surface is generally bare soil. The excavation for the foundation trench extends about 2 ft deeper than the level of the surrounding excavations. There is also a ledge of unexcavated soil immediately on the south side of the survey area; this ledge rises roughly 3 ft.

Structure 163 was intruded into by a 20th-century gate at the time that the James River ferry departed just to the south; those disturbances are marked with hachured lines in [Figure 1](#). The edge of the dome is closest to the area of survey at the northwest corner of [Figure 1](#), where it is only 1 ft away. Before the conductivity survey was started, movable metal was taken from the area of survey. These items were a wheel barrow, a sump pump (near E9782 N9702), and a loose rope that contained nails along its length. The in-place metallic grid markers were not moved; these markers were nails through canning lids and were found at E9790 N9700, E9790 N9730, and near E9786 N9728. There may be a few additional isolated nails in the soil in the area.

Magnetic measurements were made on the brick surfaces of two fireplaces within structure 165, which is outside the dome and north of structure 163. Maps of the bricks at these locations are shown in Figures 7 and 9. Excavations have revealed that these bricks

mark the undisturbed bottoms of the fireplaces, for ash was found directly above them. It is unknown what is below these brick layers. While the bricks in [Figure 9](#) form an almost completely flat surface, some of the bricks in [Figure 7](#) are at a greater elevation than the others; this relief is only about the thickness of one brick. A broken line in [Figure 7](#) marks brick faces that appear to have been blackened by fire. The brick elevation is higher there and at the eastern side of the fireplace. During the time of these tests, archaeological excavations were being made within structure 165 by Dave Givens and Eric, but that work did not affect the geophysical measurements.

In June, 1994, I did a geophysical survey with a ground-penetrating radar survey in the area of the present tests. The report on that survey was prepared for David Orr (National Park Service) and dated 8 July 1994. The correlation of the predictions of the geophysical survey with the excavation finds is discussed in an APVA note titled *Geophysics Re-visited*, and furnished to me by Eric Deetz. It appears that the radar survey detected the brick rubble from the northern chimney that had fallen in structure 163; it also detected a large pit (feature F-5, pit 4) north of structure 163. However, the archaeological importance of neither feature could be determined by the radar survey. The radar survey failed to detect the fort's trenches or the foundation of structure 163. It probably detected few of the graves to the north, and it is likely that no significant part of structure 165 was revealed by that survey. A detailed comparison of excavation finds with the radar survey is still needed.

I thank Eric Deetz for coordinating this experiment; he also furnished base maps for the areas of work. The preserved archaeological surfaces that were needed for these tests were possible due to the foresight of Bill Kelso and Eric. I thank them for their interest in having these experiments done at their site.

### **The Geophysical Surveys**

Two different geophysical instruments were applied to this work. The *conductivity* survey was done with a model EM38 electromagnetic induction meter that was manufactured by Geonics. The instrument measures the surface-weighted electrical conductivity of the soil to a depth of roughly 5 ft. I used this same instrument for several surveys on Jamestown Island that I did in 1993 for the National Park Service.

The EM38 is about a yard long, and in fact it looks similar to a carpenter's level. The conductivity of the soil is measured by the induction of a magnetic field from a coil at one end of the instrument to an identical coil at the opposite end. An analog meter on the EM38 quantifies this reading of conductivity. A data logger was used to digitize and record these conductivity readings; this logger was a model dl-3200, manufactured by Metrosonics. The logger was programmed to record the conductivity at time intervals of 1 s; the traverse speed with the EM38 was set at 1 ft per second along lines so that the measurement interval was 1 ft. The resulting map of conductivity is plotted in [Figure 3](#).

Recorded traverses were made along north-going lines. Parallel lines were spaced by 1 ft and the survey progressed toward the east. A non-elastic guide rope had locational

markers at intervals of 5 ft, and it defined the lines of traverse. This rope was moved every three traverses, since a 1-ft offset could be estimated. The grid was established with the aid of the two archaeological coordinate markers on line E9790. An optical right angle sight was used to define lines N9700 and N9730, and marks were set at 2-ft intervals along those lines to allow the ends of the guide rope to be positioned.

The magnetic dipoles of the EM38 were vertical, and the length of the instrument was north-south (At N9700, the instrument was east-west because of the earthen ledge). It was carried with a sling so that the bottom surface of the instrument was just above the excavated surface wherever possible. Because of the care needed in walking on the archaeological surface, and the difficulties of the foundation trench, the instrument height was rather irregular at some locations. It was typically difficult to drop the instrument into the foundation trench, and the anomalies that are elongated north-south in the northwest corner of [Figure 3](#) reveal these errors; the map is unreliable there. Errors in lateral position are also likely, but these may seldom exceed 1 ft. Since the site was shaded by the dome, the EM38 was not encased in thermal insulation.

The interval between the contours in the conductivity map of [Figure 3](#) is 2 millisiemens per meter (mS/m); enclosed low areas have tick marks along the contour lines.

A segment of a modern pipe remains at the southern side of the survey area, and the extreme readings of apparent high and low conductivity there are not fully-contoured; the blanks and the abrupt change in the spacing of the contour lines reveals these areas. This metallic pipe is approximated in [Figure 1](#); on the conductivity map, it is revealed by the typical alternating pattern from high (west of the pipe) to low (directly over the pipe) to high (east of the pipe).

Before this survey was started, it was anticipated that the metal frame of the dome would prevent good conductivity readings below it. Metal surfaces (such as steel roofing) or meshes (such as woven wire fences) cause conductivity anomalies for a distance of at least 15 ft from those objects; large wire loops that help support tree branches in orchards are also readily detected by EM instruments. The aluminum framing of this dome appears to have had very little effect; perhaps this is because it was typically more than 20 ft overhead. The calibration settings of the instrument were quite different inside the dome as compared to outside, and perhaps this reveals the effect of the metal. No periodic pattern was found in the conductivity map that matches the cell spacings of the dome's framing.

The average electrical conductivity of the soil was about 12 mS/m and this indicates that there must be a large fraction of sand or other low conductivity materials in the soil. A laboratory measurement of a sample of subsoil from the site indicated a high conductivity of over 80 mS/m; the cause of this large difference is not known.

There are three or four conductivity lows that have a very small area; most of these are caused by a single low reading. These may be caused by excavator's nails, errors in the measurements, or by small metallic artifacts that are less than 1 ft underground. The actual locations of the objects could be 1.5 ft distant (north-south) from the lows.

Electrical interference to the EM38 was tested with a series of repeated measurements; these are plotted in [Figure 15](#). The noise was slightly higher than expected; this may be due to the electrical wires that go to the fans and lamps in the dome.

The *magnetic* measurements were made with a instrument that allowed high spatial resolution (better than 1 cm), with the sensor very close to the archaeological surface (less than 2 cm distant). The magnetometer was a model FGM-5DTAA triaxial fluxgate instrument, manufactured by Walker Scientific. This instrument has three sensors that are inside a housing that is an inch square in cross-section; each sensor measures a perpendicular component of the earth's magnetic field (North, East, and Down). An electrical cable that is about 5 ft long connects this sensor to an electronic readout. The electronics within this readout can determine the vectorial sum of the three components (without a correction for the small offset between the sensors) and the total field is displayed to a precision of 1 nT. While the measurements can be recorded in the instrument's memory, they were written down for these tests.

Magnetic measurements were made by setting the sensor directly on the top of bricks, and recording the magnetic field. These magnetic tests were done in five different areas. Just before starting the measurements in each area, a reference reading was made with the magnetic sensor several feet above the feature. This reading was automatically subtracted from all of the following readings in that area. The reading with the elevated sensor approximates the natural field of the earth in the vicinity, and this subtraction allows changes from the earth's field to be seen readily in the measurements; these reference or zero-anomaly readings are listed with each of the figures.

The sensor was set near the middle of each brick or brick fragment that was measured; no attempt was made to record the large changes that occur across the face of the brick. The magnetic anomalies were so large that no correction was needed for the temporal change in the earth's magnetic field. Within the housing of the sensor of the Walker magnetometer, the center of the sensor is 1.3 cm above the base; the height of the measurements above the brick surfaces was therefore about 1.5 cm.

The magnetic measurements at brick area 1 are listed below. The magnetic anomaly (in nanotesla, nT) follows the brick number; the reference zero field was 52,000 nT.

1	-13	8	-677	15	-141
2	-975	9	-22	16	-234
3	-281	10	434	17	43
4	107	11	564	18	-329
5	567	12	-1561	19	-576
6	-66	13	-139	20	-485
7	-17	14	-75	21	-647

The distribution of these readings is revealed in [Figure 4](#); the count of the anomalies in 200-nT wide intervals are plotted there. The area under this frequency distribution curve is the same as the area under each of the following curves, for the count in each span has been

divided by the total number of sampled bricks in each area.

The field work of this geophysical survey was done on November 13, 2001. That day was warm and the sky was clear. There had been several weeks without any significant rainfall in the area.

### **Findings of the Geophysical Surveys**

The important results of the conductivity survey are plotted in [Figure 2](#); these findings are derived from the conductivity map of [Figure 3](#).

The low conductivity band that extends to the northeast reveals an anomaly that has a polarity, amplitude, and width that could reasonably be caused by an extension of the fort's trench. However, it may not reveal the trench. While part of the known trench was within the area of survey, its conductivity contrast could not be reliably measured during the mapped survey because of difficulties caused by the topographic drop at the nearby foundation trench of structure 163, and the wires and framing for the dome (which are just to the west). For this reason, a series of separate measurements were made at slightly different locations over the fill of the trench and also outside it; the averages of these readings are listed on the left side of [Figure 2](#). The conductivity directly over the trench ranged between 7 and 8 mS/m; north of the trench, it was 8 - 16 mS/m; south of the trench, it was 15 - 18 mS/m. Therefore, the conductivity reading at the trench may be about half the conductivity of the surrounding soil. The conductivity map of [Figure 3](#) shows that the low readings along the northeast band drop to 4 - 8 mS/m, while the surrounding soil has a conductivity of about 12 mS/m.

The excavation of the fort's trench suggests that it may extend to the southeast, rather than the northeast; this is evidence against an interpretation that the low conductivity band marks the path of the trench. Note also that the southern end of the low conductivity band begins at an area of burned or charred wood. I can recall only one other site where I have done an EM38 survey over similar material. This was a geological search for ancient, buried trees in northern Canada; carboniferous strata were detected as low conductivity there. Therefore, it is possible that a line of this charred wood has been traced below structure 163. It is also possible that some other band of soil has been delineated; this soil probably contains a greater fraction of sand or gravel than normal. While the conductivity anomaly is not huge or perfectly linear, its pattern did repeat on at least nine parallel lines; this means that there must be a clear cause for it within the earth.

While the measurements indicate that the conductivity of the fill of the fort's trench is lower than the conductivity of the surrounding soil, there is one complication. Features that are smaller than the length of the EM38 (3 ft) can cause anomalies that have the opposite polarity of what is expected. The fort trench is somewhat larger than this, but this caution must still be kept in mind. Nevertheless, the polarity of the anomaly from the linear band is the same as that measured separately over the trench fill; therefore, the fill of the undiscovered trench should still be expected to be detected as lower conductivity than normal.



There is definitely no linear pattern than extends to the southeast in [Figure 3](#). There are two areas of low conductivity, and it is possible that these could be caused by parts of a filled trench there. While the metal pipe interferes with the measurements at the south side of the area, there is still no significant anomaly near E9790 N9710, which is along a projection of the excavated fort trench in its south-easterly direction.

The EM38 conductivity meter was not designed for detecting metal, but it does it rather too well some time. Shallow metallic objects are detected as a small area with unusually low readings. There are several locations on the map of [Figure 3](#) where these low readings are found; at these locations, the apparent conductivity was below 2 mS/m or even negative. Natural earth materials in this area probably cannot cause readings below 2 mS/m, and negative readings are definitely impossible.

There is a metallic rod that extends out of the excavation of the foundation trench of structure 163. This was clearly-revealed by the conductivity survey with a bull's-eye of a half dozen low readings. The asterisk at the bottom of [Figure 2](#) locates the lowest reading and also the end of the iron rod. It is very likely that there is another metallic object near E9795 N9714; it is also marked with an asterisk in [Figure 2](#). There could be another metallic object to the northeast, or a single long object could extend in that direction. This object is probably less than 1 ft underground; it will probably, although not certainly, be detectable with a typical metal detector.

The first goal of this work was a prediction of the eastward line of the filled ditch of the early fort; those ambiguous findings are described above. The second goal of this work was an estimation of whether structure 163 was destroyed during a conflagration. If the chimney fell during a long-lasting and hot fire, its bricks would have been remagnetized on the ground by having been heated to a high temperature. This remagnetization is readily detected in brick, but the survey found no indication of it. However, magnetic measurements on the bases of two nearby fireplaces also found no firm evidence of remagnetization; this makes the results at structure 163 less certain.

The effects of brick firing and remagnetization are illustrated in [Figure 11](#). For the measurements there, I selected nine bricks from near my house (these are not old bricks, but that does not make any difference). I found the magnetic poles of these bricks with an audio-indicating magnetometer, and I noted the approximate location of each north pole on each brick. These poles were always on the edge of the bricks (the edge is the medium-sized face); this is because bricks are typically set on their edge while they were fired in a kiln. Since the magnetic field of the earth in this area has a dip angle of about 70° (only 20° from vertical), the poles of the permanent magnet that is formed by firing must be on the edges of the bricks.

I set the bricks next to each other and aligned their north poles so that the permanent magnetic field of the all of the bricks would add to the earth's field; the line segments at the bottom of [Figure 11](#) locate the nine bricks. The solid line curve in the figure shows the measurements that were made with the Walker magnetometer. Some bricks are more



magnetic than others and these cause extra peaks on the broad high; the lows off the ends of the line of bricks are normal. These measurements are a good approximation of those that would have been found if these bricks had been fired in place.

For a second series of measurements, I turned alternate bricks upside down. The dashed line in [Figure 11](#) shows these measurements. There is a much larger variability in the measurements, and half of the measurements are less than the earth's field (the horizontal dashed line), and half are greater. The large undulations on the dashed line curve are due to the addition and subtraction of the permanent magnetic field of each brick from the field of the earth. These large undulations are a clue that these bricks have not been fired in place.

The measurements in [Figure 11](#) show an almost identical pattern to the calculations that I plotted in [Figure 11](#) of an earlier study (Geophysical Detection of Brick Structures, dated 11 October 2001).

A further examination of the refiring of bricks is illustrated in Figures 13 and 14. The four magnetic maps in each figure show a small rectangle that locates the large face (or flat) of a brick. The contour lines in the figures are calculations that plot the magnetic field above the bricks; the contour interval is 200 nT. Each figure shows four stages in the remagnetization of a brick; for each stage, a different fraction of the brick has been remagnetized.

In the upper left area of each figure, there has been no remagnetization, and the permanent magnetic pole is assumed to be toward the right, out one of the edges of the brick. In [Figure 13](#), the brick is remagnetized through horizontal layers. For the upper right example, the uppermost 20% of the brick has been remagnetized, and the direction of the earth's field is toward the top of each figure. Note that the magnetic low rotates from east to north as the brick becomes fully-remagnetized.

[Figure 14](#) shows different conditions for this remagnetization: The brick is assumed to have been heated and remagnetized on the eastern side. For these four calculated maps, the low also rotates from the east to the north with increasing remagnetization.

These calculated maps assume the following: The present (remagnetizing) earth's magnetic field is 52,500 nT at an inclination of 67° toward the top of each figure. The original remanent magnetization is to the right, with an inclination of 0°. The remanent magnetic moment of the brick is 0.01 Am<sup>2</sup>; the induced moment is an eighth of that. The bricks have dimensions of 20 x 10 x 6 cm (the large face is about 4 x 8 inches). The calculations were made at a height of 3 cm above the top of the brick.

Figures 13 and 14 both show that a fully-remagnetized brick will have a magnetic high that extends over the entire upper face of the brick. These figures also show that a brick that has not been remagnetized can have a magnetic anomaly on its upper surface that is half high and half low. This effect was further studied by additional calculations, with results in [Figure 12](#). This figure approximates the magnetic anomaly over the top of a brick that has been rotated to random angles. If the brick has strong remanent magnetization, half of the magnetic anomalies will be highs; this should also be the ratio of highs for bricks in an

archaeological structure that has not been refired. If the bricks have a strong induced magnetization relative to their remanent magnetization, then all of the anomalies will be magnetic highs. Since bricks appear to always have a much stronger remanent than induced magnetization (the Q ratio is typically 5 - 15), then the ratio of magnetic highs to lows can be a good indicator of whether bricks have been fired in place. If a structure has been fired in place almost all of its anomalies should be highs; if the structure has not been fired in place, only about half of the anomalies should be highs.

These statistical measurements were made on bricks at five locations in structures 163 and 165. All of these measurements gave almost the same result, and the frequency distributions of the magnetic anomalies are plotted in Figures 4, 5, 6, 8, and 10. Each of these distributions are almost equally-distributed to the positive and negative anomaly side of the graphs. This can be seen by a visual examination, and the low values of the medians of the measurements also show this. This indicates that there could not have been complete refiring of the bricks at any of these areas; even a refiring through only 50 per cent of each brick is almost impossible. It is indeed possible that only a thin, outer layer of the bricks has been remagnetized; this would not have been detected by these measurements. (A later experiment may be made with very high resolution magnetic measurements across the face of a brick that looks like it has been blackened and burned in a fireplace).

The measurements on the bricks at the five locations did find that the bricks fallen from the northern chimney of structure 163 were much more magnetic than the brick at the other four locations. This could be caused by a different source for the clay, or perhaps by different firing conditions in the kiln. The statistics on these bricks are plotted in [Figure 6](#); six anomalies exceeded the plot range of +/- 3000 nT, and these counts are added at the ends of the plot.

At two of the test areas (2 and 3), there were only jumbles of random brick at the surface, the locations of the bricks for the measurements were not recorded. For the other three test areas, the locations of the measurements at specific bricks were plotted; Figures 7 and 9 show the findings in structure 165. In these figures, small areas that have been refired might be indicated by islands of readings where the anomalies are almost entirely positive. [Figure 7](#) shows such an area on the eastern side, near E9800. There is a metallic grid marker near E9800 N9810, but this does not change the pattern much. There is also an area where magnetic highs predominate near the dashed line in [Figure 7](#), and this may mark the rear of the fireplace. These areas may indeed have been refired in the fireplace, but accidental and coincidental alignment of the bricks in those areas can also cause clumps that show these groups of positive anomalies. As a second test of this effect, it would be valuable to make a high resolution magnetic map of this brick surface using the Walker magnetometer.

The pattern of the magnetic anomalies over the brick layer of the bottom of the northern fireplace of structure 155 is plotted in [Figure 9](#). This shows a line of high readings on the east side. Again, this may suggest the possibility of refiring there, although this pattern could also be a coincidence. Neither of these fireplace bottoms could have been fully-refired

by the former fires there, for there are too many magnetic lows with the measurements.

## **Conclusions**

The conductivity measurements have hinted at some information that might assist with the planning of the future excavation of structure 163. If the extension of the fort's ditch below structure 163 has the same cross-sectional area and character as it has west of that structure, the conductivity survey could have clearly shown its path had it extended to the southeast from its last known position. While there is a faint anomaly along that line, a much clearer anomaly extends to the northeast.

The magnetic measurements on the bricks of structure 163 have suggested that those bricks have not been refired where they sit. However, additional tests on the bricks in the fireplaces of structure 165 are needed in order to quantify the effects of a minor amount of refiring that has affected only a rather thin layer of the brick.

## **Publication history**

30 March 2009: Converted from paper copy to this PDF version; a few figures were changed by adding color.

26 November 2001: Original paper version.

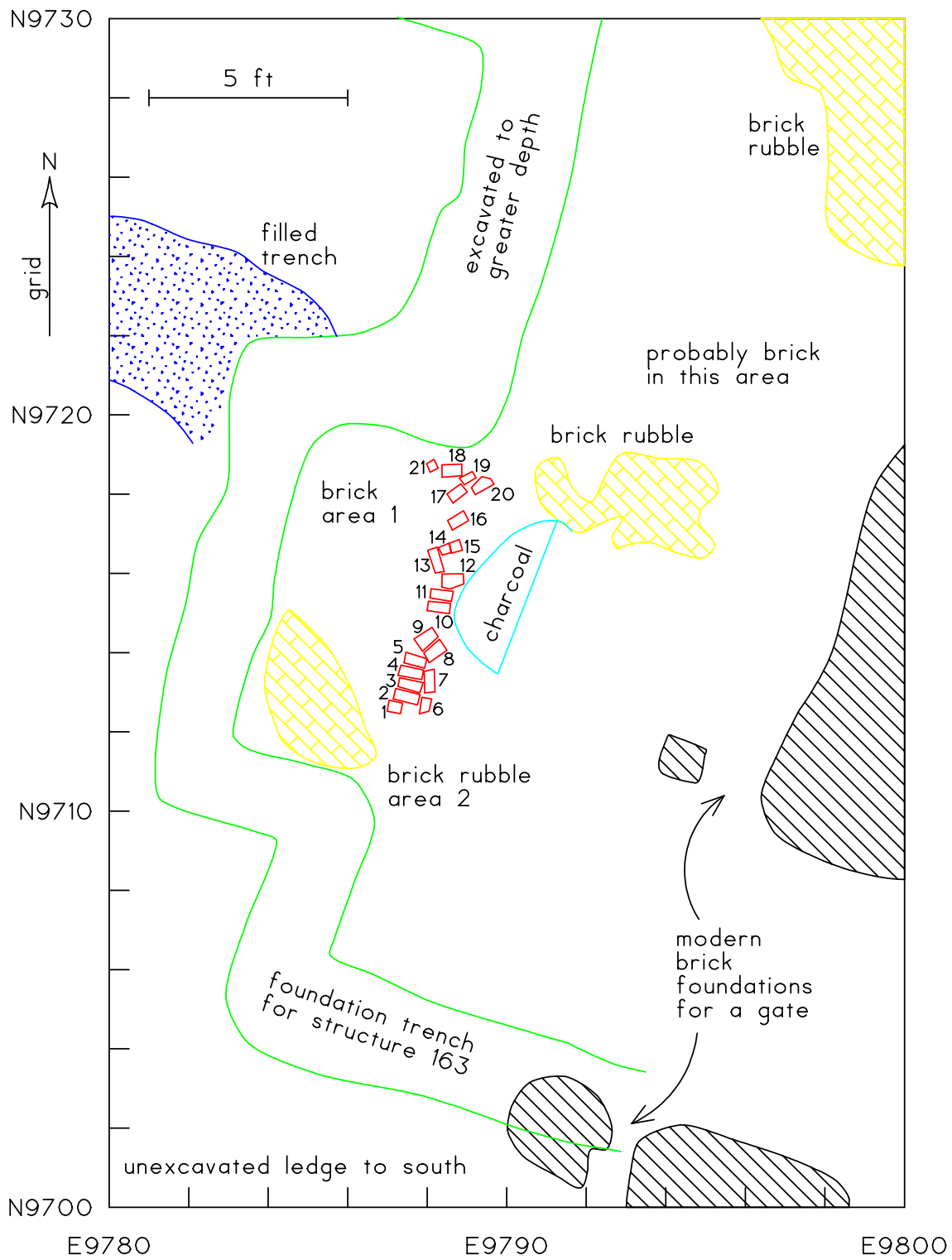

Figure 1: The area of the conductivity survey. The filled trench of the early fort is indicated with a stippled band on the left. The goal of this survey was a search for an extension of this trench below structure 163. This map is a simplification from one that was supplied by Eric Deetz. During the time of this survey, the area was covered by a fabric dome that is supported by an aluminum frame.

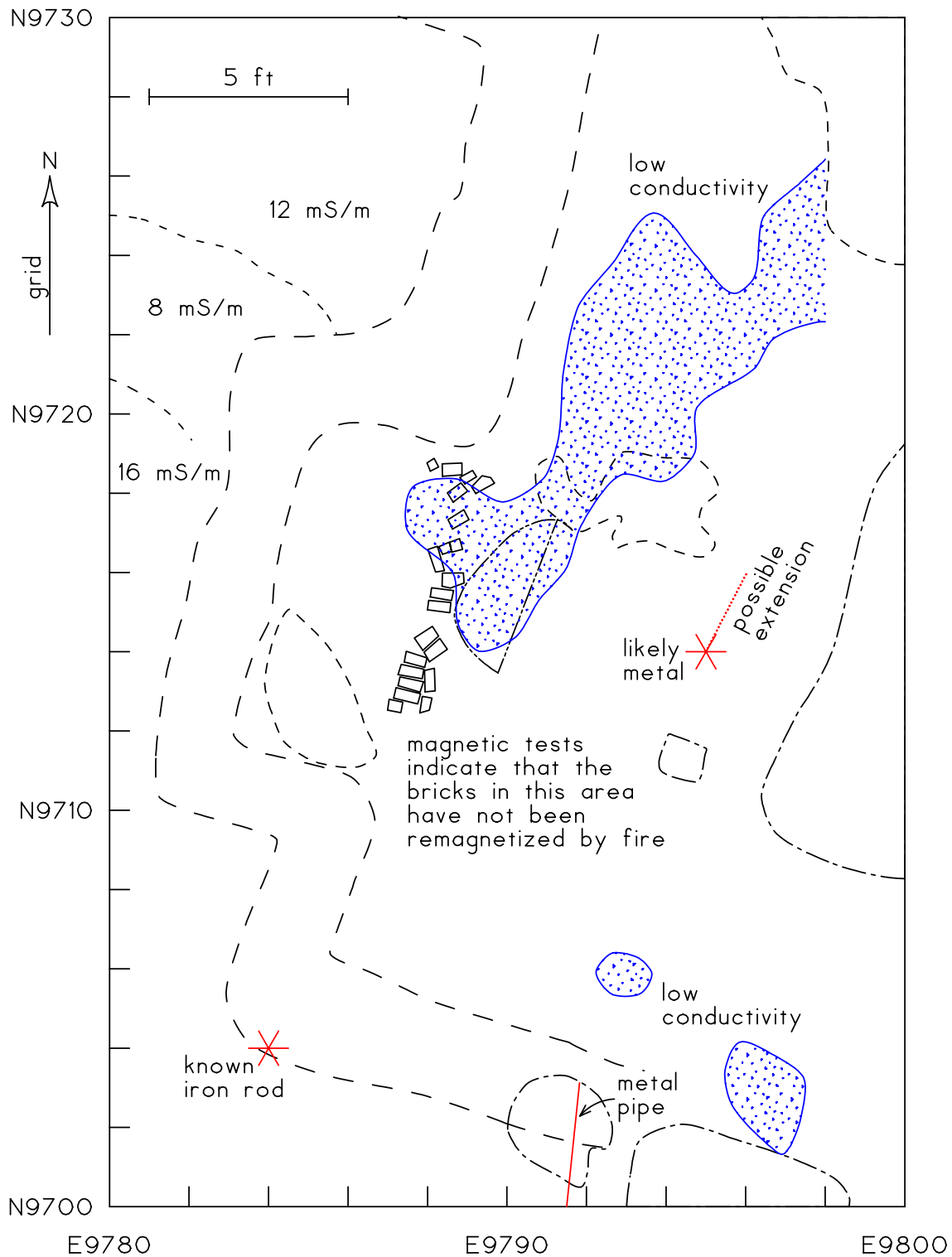

Figure 2: The findings of the conductivity survey. A band of low conductivity was found to extend to the northeast; this is marked with a stippled pattern. Two other areas of low conductivity were found in the southeast. The fill of the trench was found to have relatively low conductivity; three measurements of the conductivity of the soil near the trench are listed on the left side of the figure.

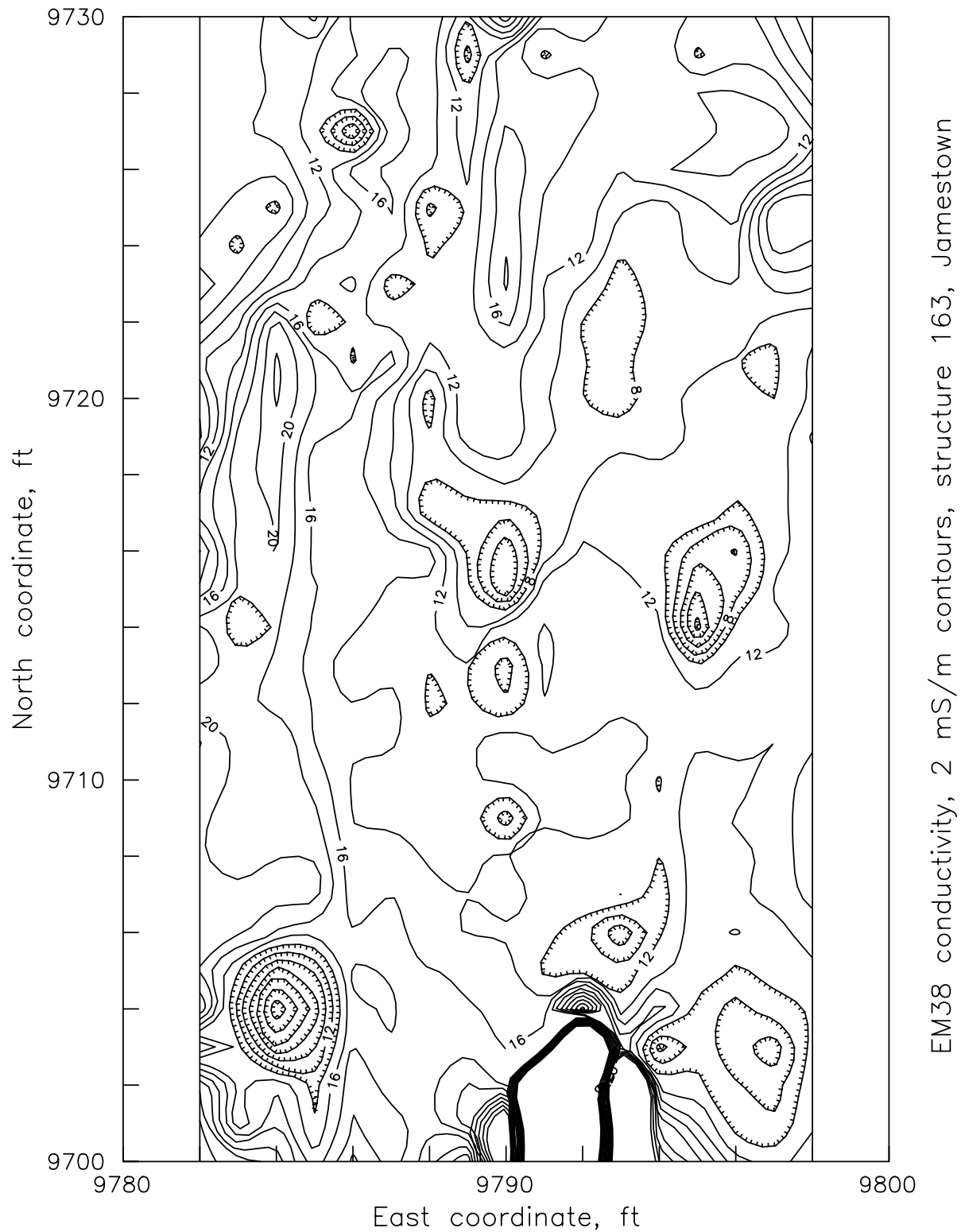

Figure 3: The conductivity map. A visible segment of a pipe causes the complex pattern at the bottom, near E9792 N9700. A known iron artifact in the side of the foundation trench causes the low readings near E9784 N9704. It is likely that there is undiscovered buried metal near E9795 N9714, at another area of low measurements.

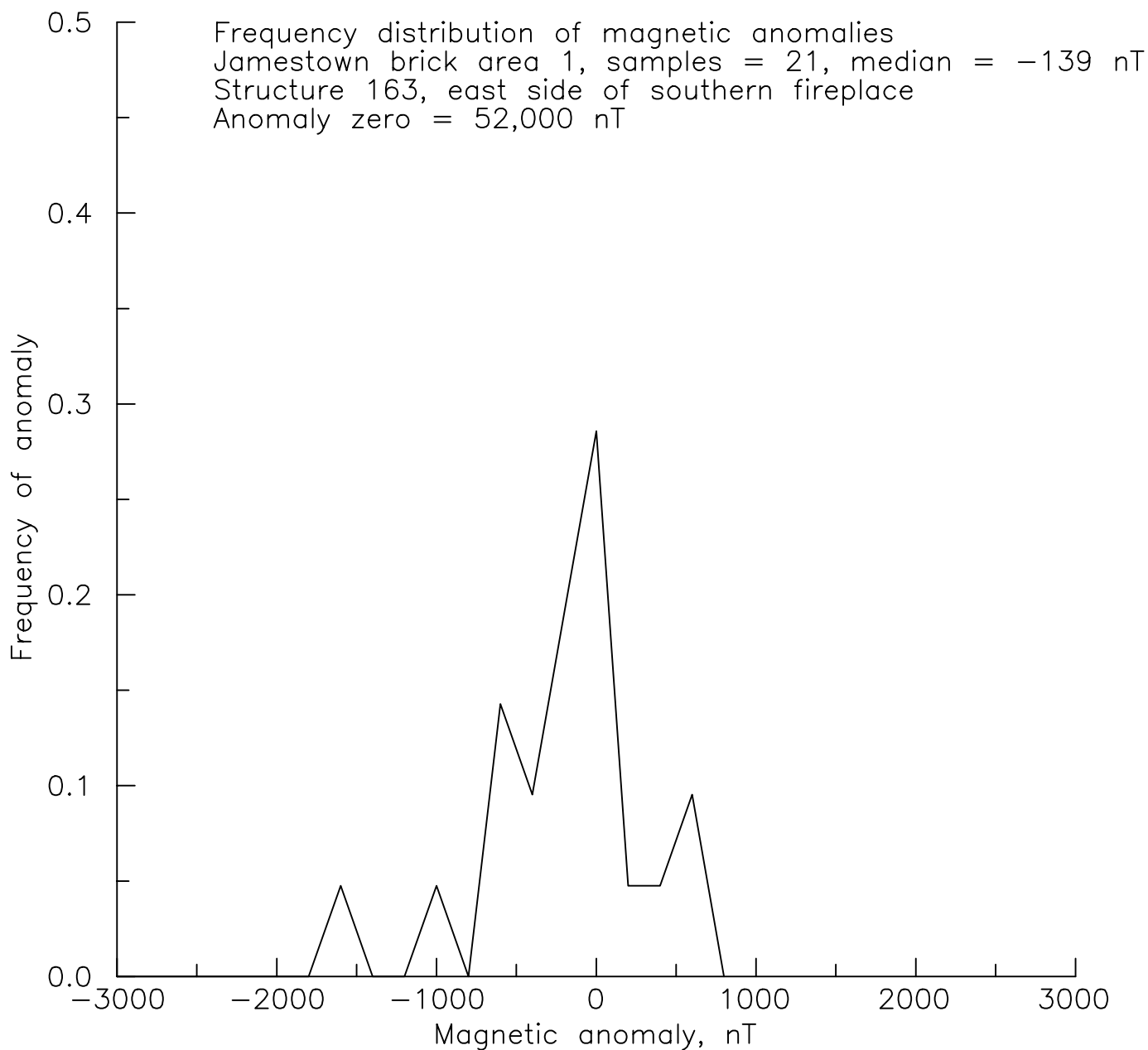

Figure 4: Statistics on the magnetic anomalies that were measured over brick. These bricks are numbered 1 - 21 in [Figure 1](#), on the east side of a former fireplace. The measurements were made with the magnetic sensor at a height of 1.5 cm above the middle of the top of each of the bricks. Since the median magnetic anomaly is near zero, this geophysical test indicates that the bricks at this location have not been refired.



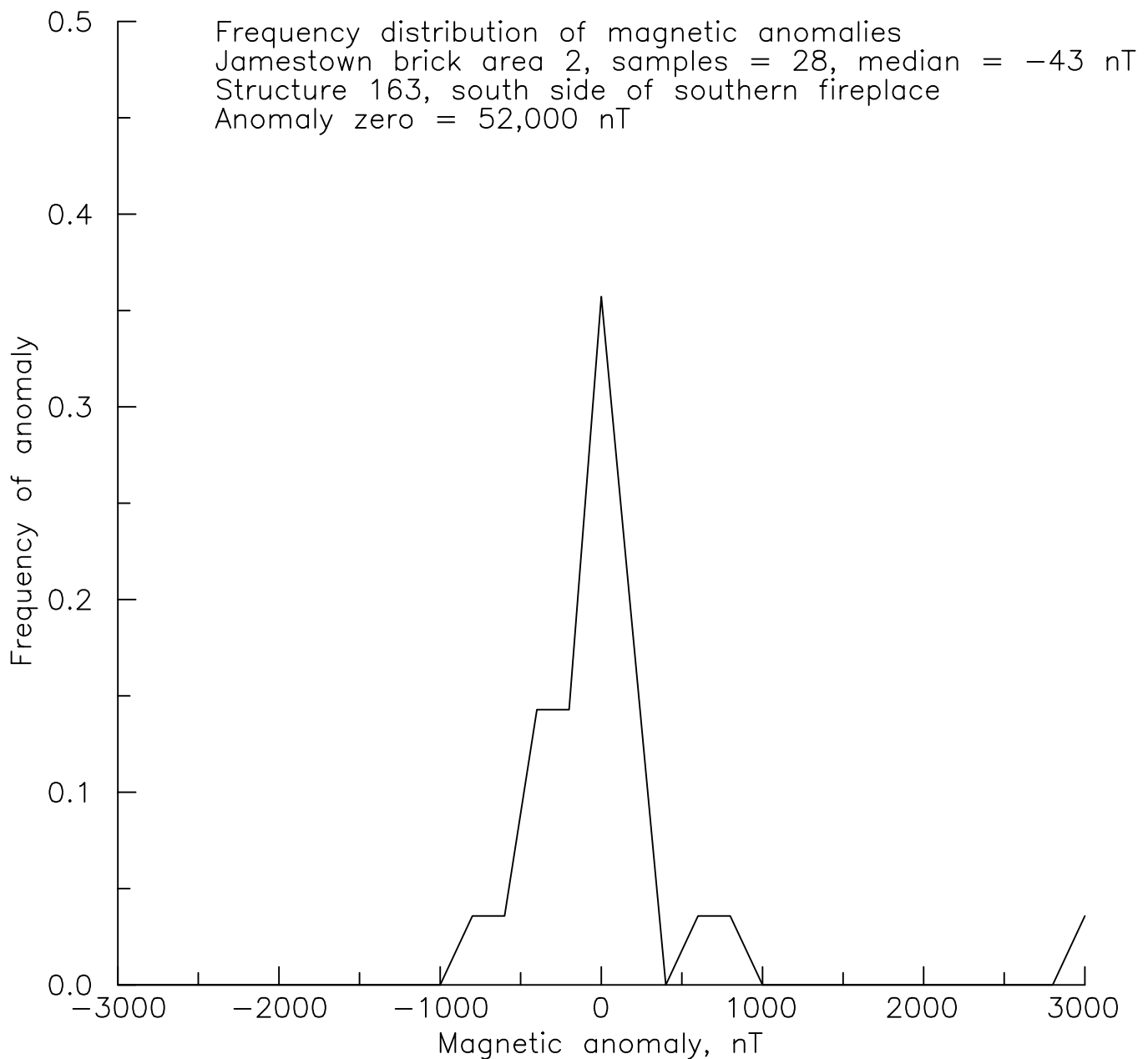

Figure 5: Magnetic anomalies of the bricks in area 2. This area was on the south side of the southern fireplace in structure 163; see [Figure 1](#). A total of 28 bricks were tested, and the median of their anomalies was also close to zero. Again, these bricks must not have been refired at this location.

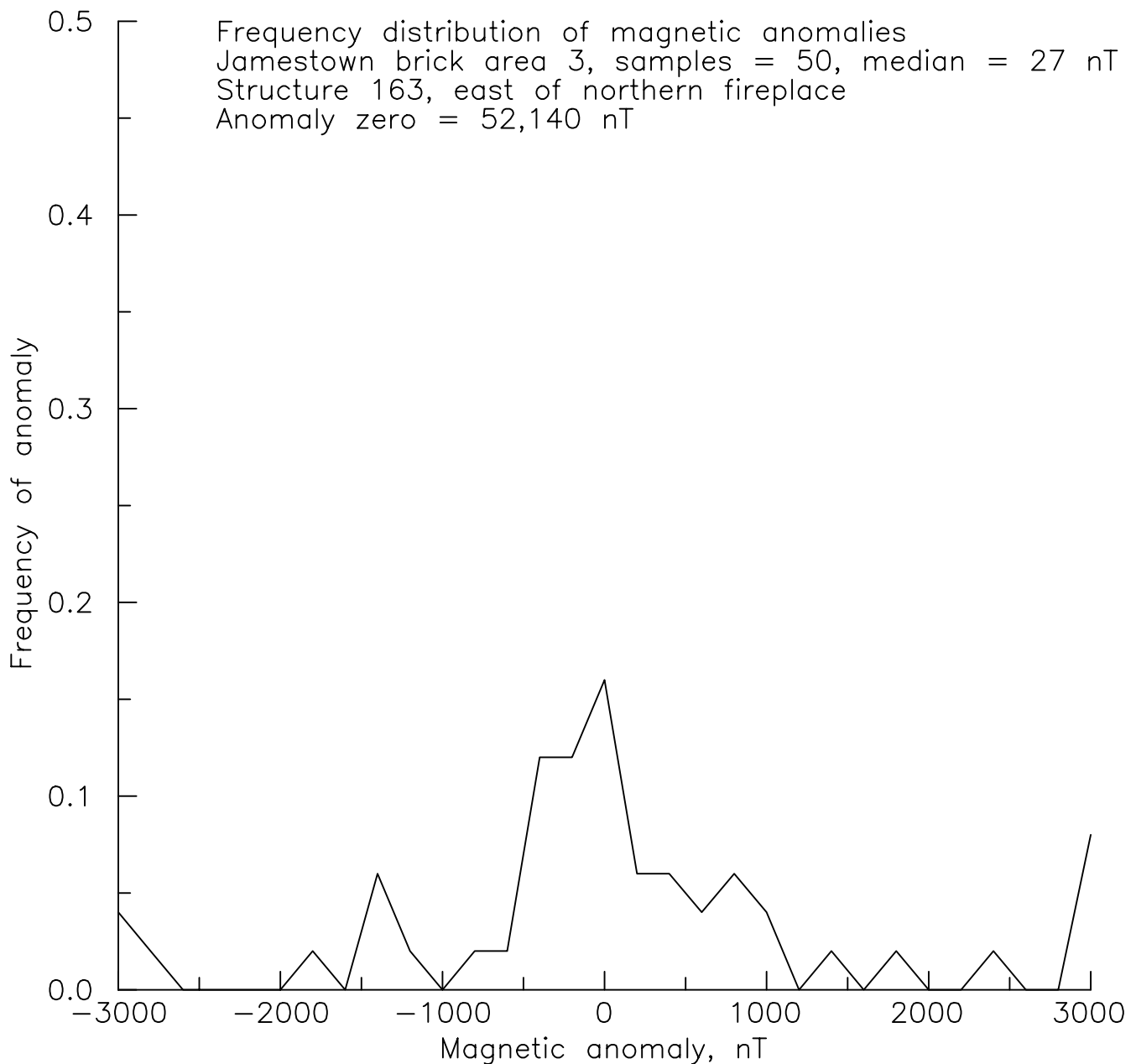

Figure 6: A third test of brick in structure 163. These measurements were made about 6 ft north of the map in [Figure 1](#), in an area where brick has fallen to the east from the northern chimney. The area is centered at E9794 N9736. These bricks were much more magnetic than those to the south; however, positive and negative anomalies are about equally-common for the 50 bricks that were tested.

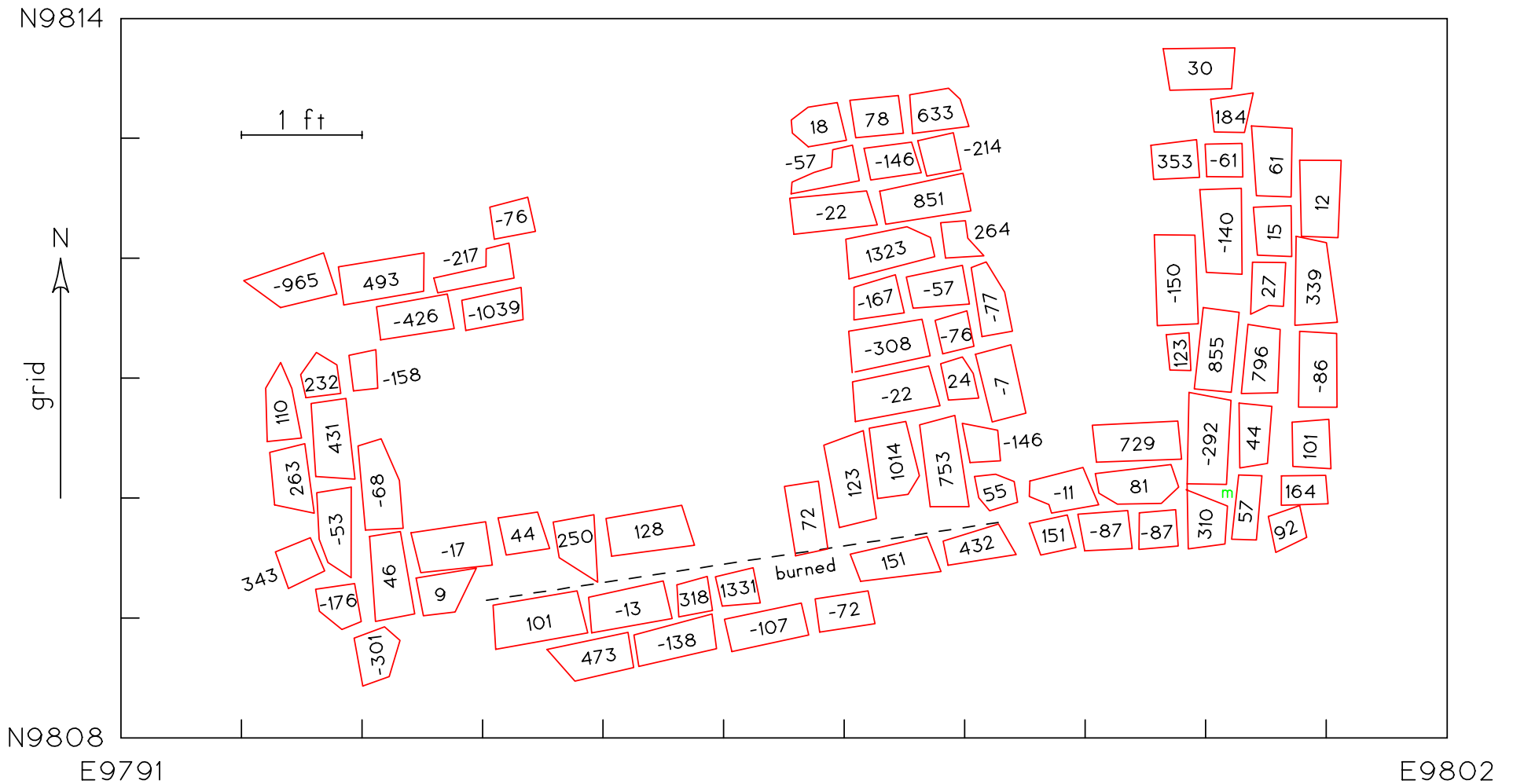

Figure 7: The southern fireplace of structure 165. This shows the bricks at the bottom of the fireplace. The magnetic anomalies that were measured at a height of 1.5 cm above the middle of the tops of the bricks are listed; the zero value of the anomaly is a magnetic field of 52,080 nT. The dashed line at the bottom of the figure marks where the northern faces of bricks are visibly burned. The brick map is an simplification of a map supplied by Eric Deetz.

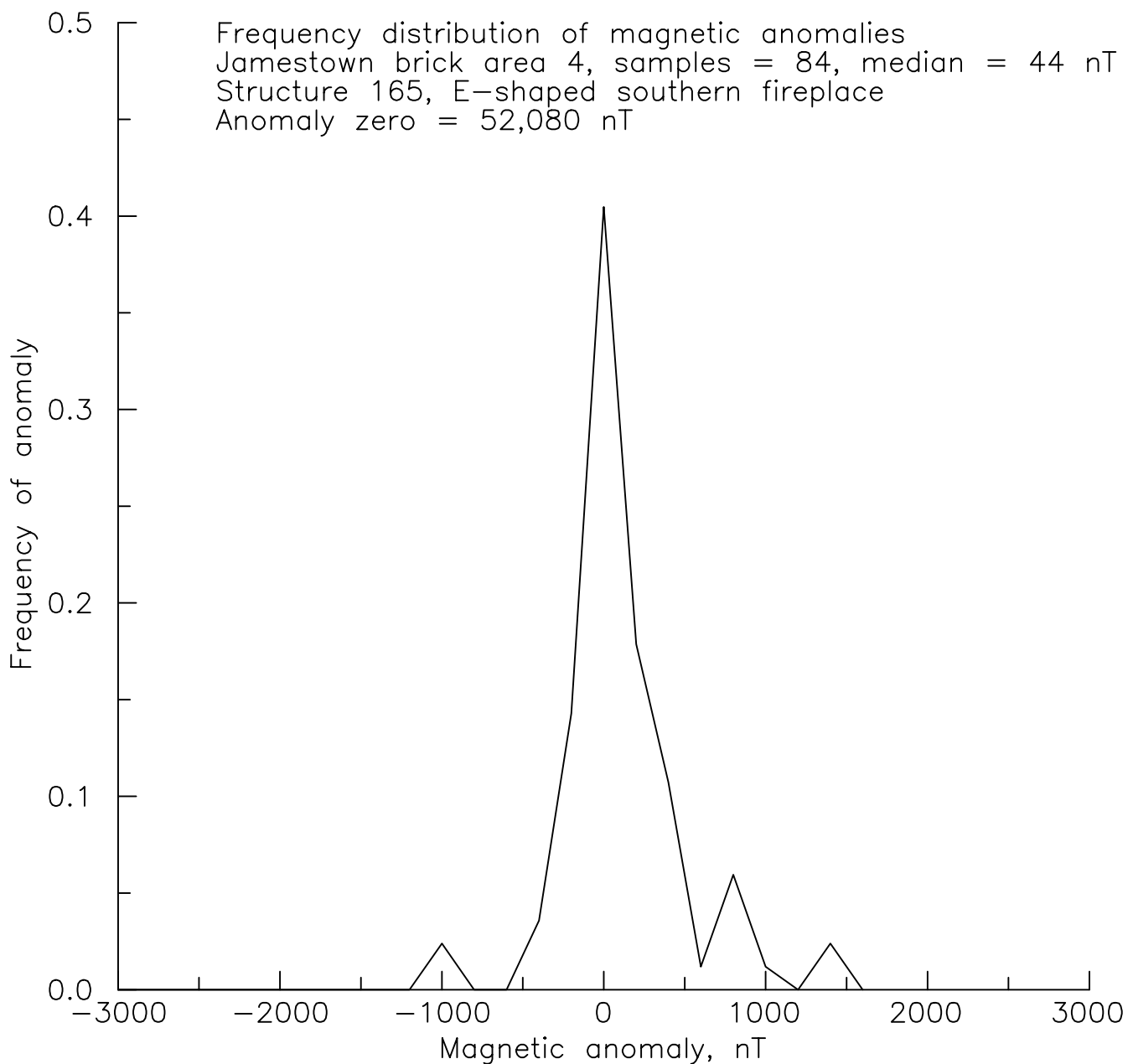

Figure 8: The statistics on the magnetic anomalies of the 84 bricks that are mapped in [Figure 7](#). The findings are similar to those in [Figure 5](#), and there is no evidence from the magnetic survey that these bricks have been completely remagnetized by a thorough refiring. The magnetic measurements were made near the middle of the upper surface of the bricks, and not near the burned layer at the edge of some of the bricks.

N9826

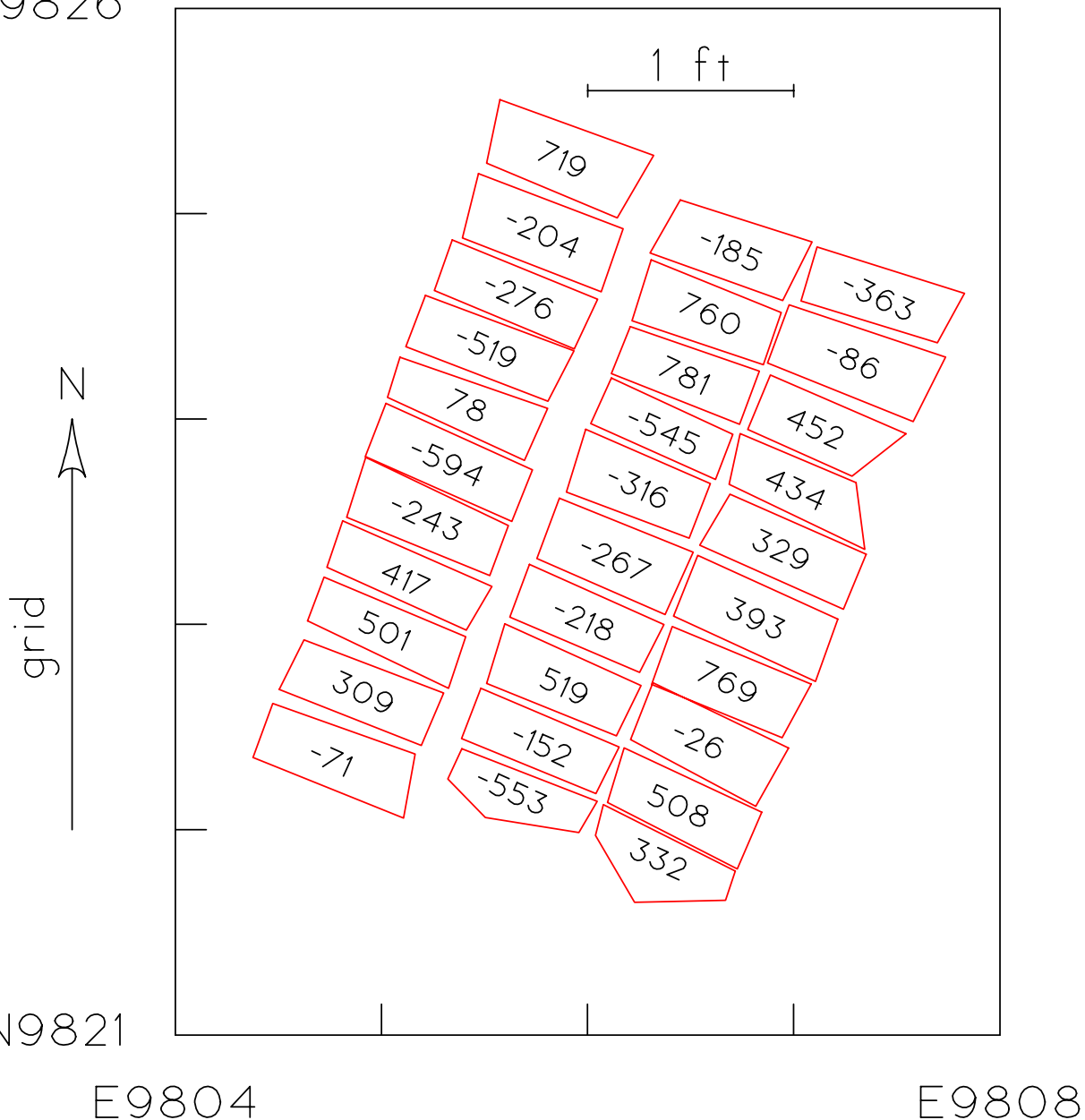

Figure 9: The northern fireplace of structure 165. This area is about 16 ft northeast of the fireplace in [Figure 7](#). The magnetic anomalies that were measured on the bricks are listed at those bricks. The reference zero field for the anomaly measurements is 52,150 nT. Like the other maps, there are islands of anomalies that have the same polarity, but there is no large area with entirely positive anomalies. Brick locations are approximated from a map supplied by Eric Deetz.

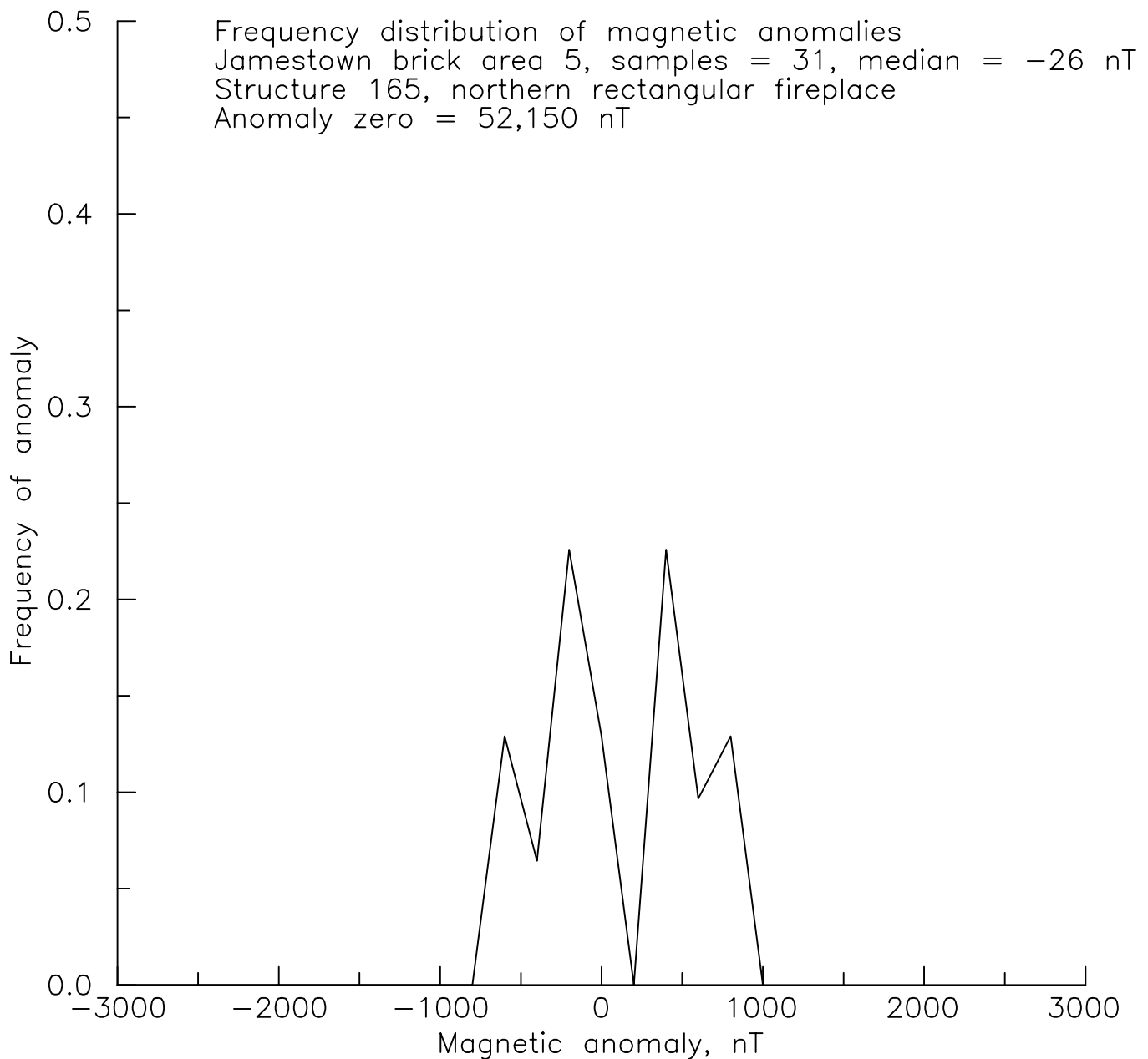

Figure 10: The frequency distribution of the magnetic anomalies of the fireplace base shown in [Figure 9](#). For this and the other figures, the anomalies are summed in spans that are 200 nT wide; the count of the anomalies in each span is divided by the total number of bricks that were measured. The magnetic measurements suggest that these bricks, like all of the others, have not been refired.

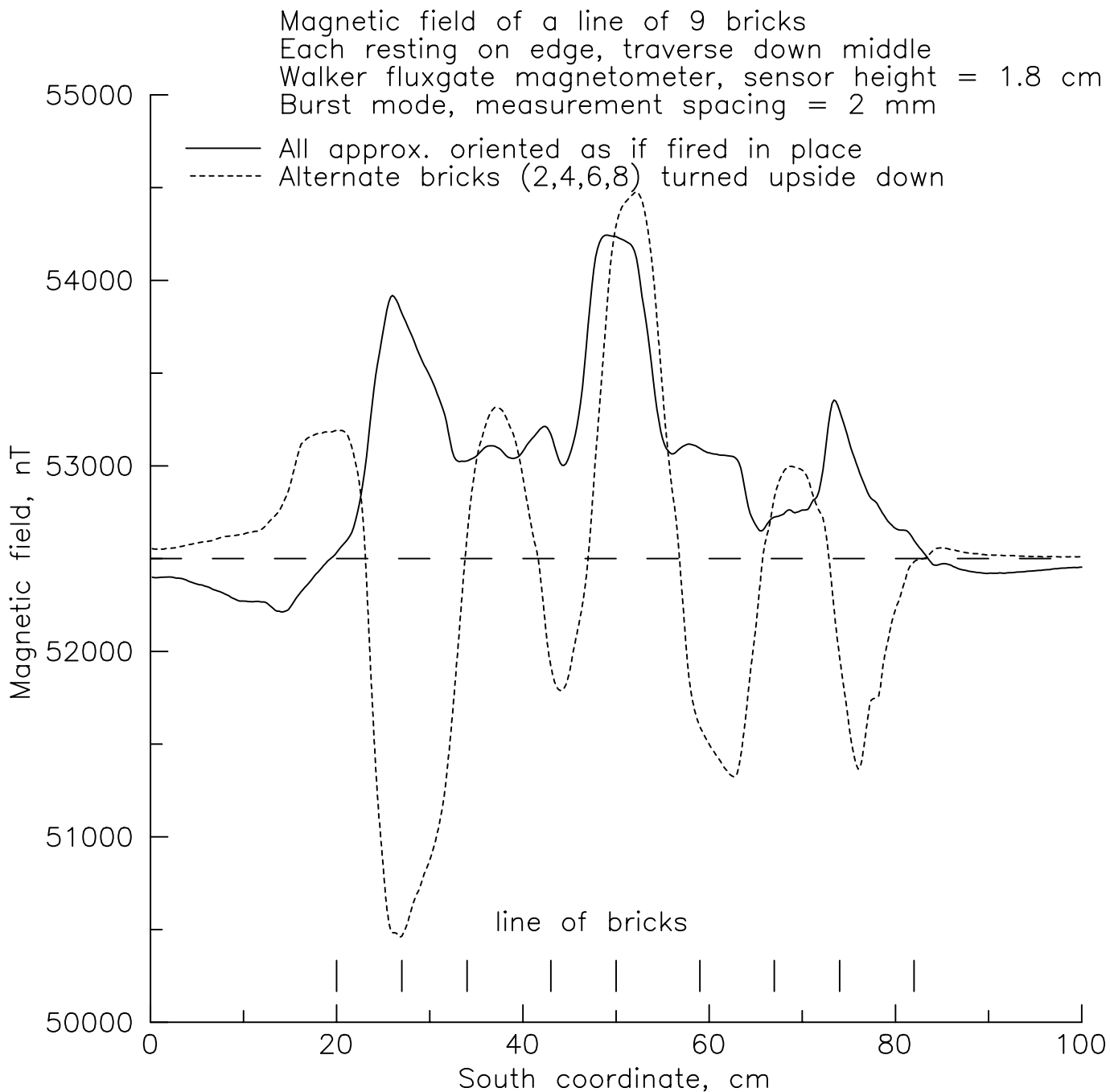

Figure 11: The difference caused by refiring. These measurements illustrate the differences between bricks that have been fired in place from those that have been moved from their place of firing. The dashed line shows the pattern that was measured over a line of disoriented bricks; this simulates the effect of bricks that have not been fired in place. The solid line shows the measurements that would be made over the same line of bricks when they have been oriented as if they had been fired in place.



Randomly rotated bricks: Percentage of positive anomalies  
 1000 calculations for each Q ratio  
 Random variables:  $M_r = 0.005 - 0.02 \text{ Am}^2$ ,  $I_r$  and  $D_r$   
 Calculation vertically above model dipole  
 $B_e = 52,500 \text{ nT}$ ,  $i_e = 67^\circ$ ,  $D_e = 0$

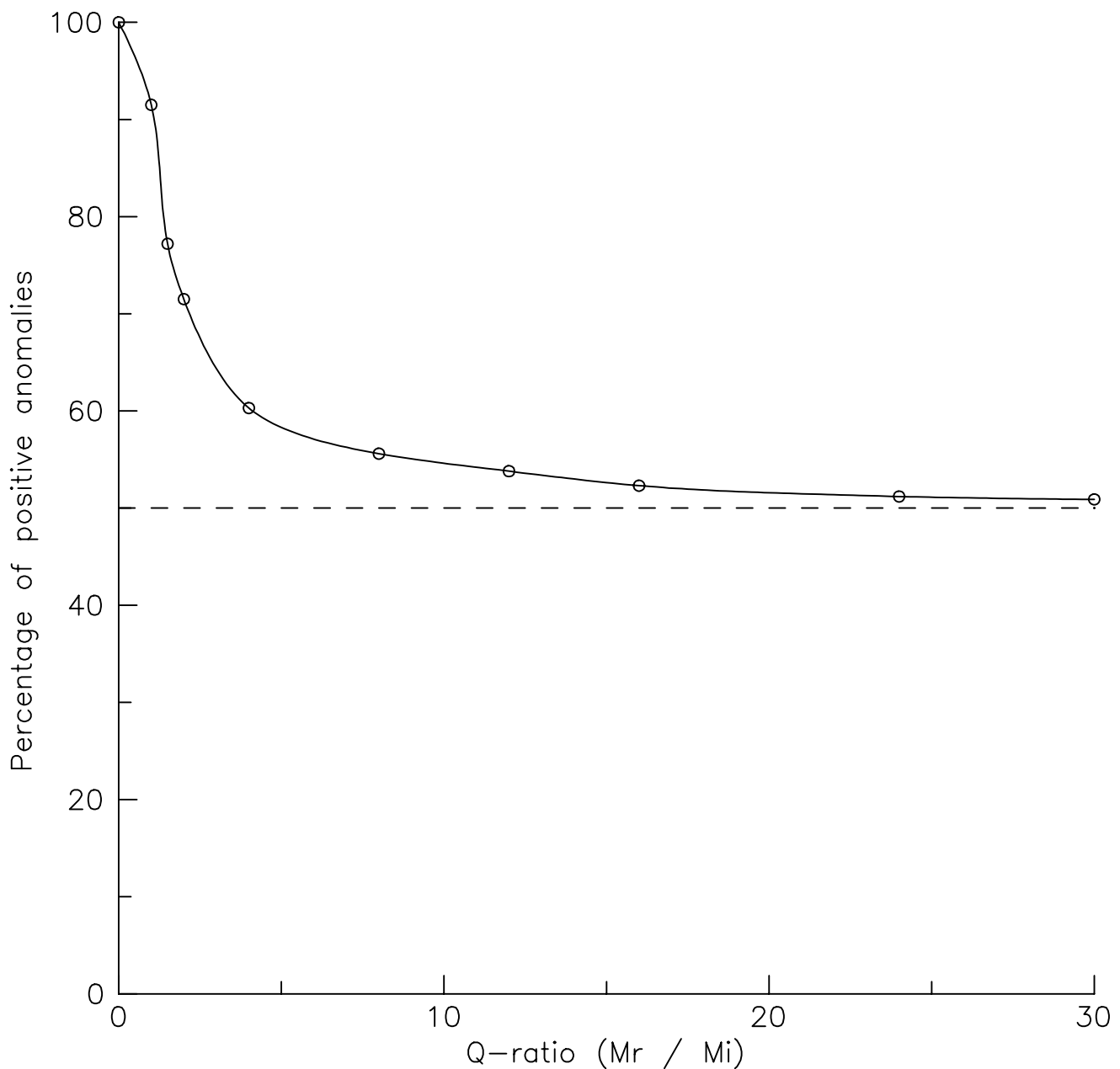

Figure 12: The statistical effect of remanent magnetization. The Q-ratio is the ratio of remanent to induced magnetization. If bricks have no remanent magnetization, the magnetic anomaly of a brick will not change with the rotation angle of the brick; all anomalies will be positive. If the brick has only remanent magnetization, half of the bricks will have positive anomalies, and half will have negative anomalies.

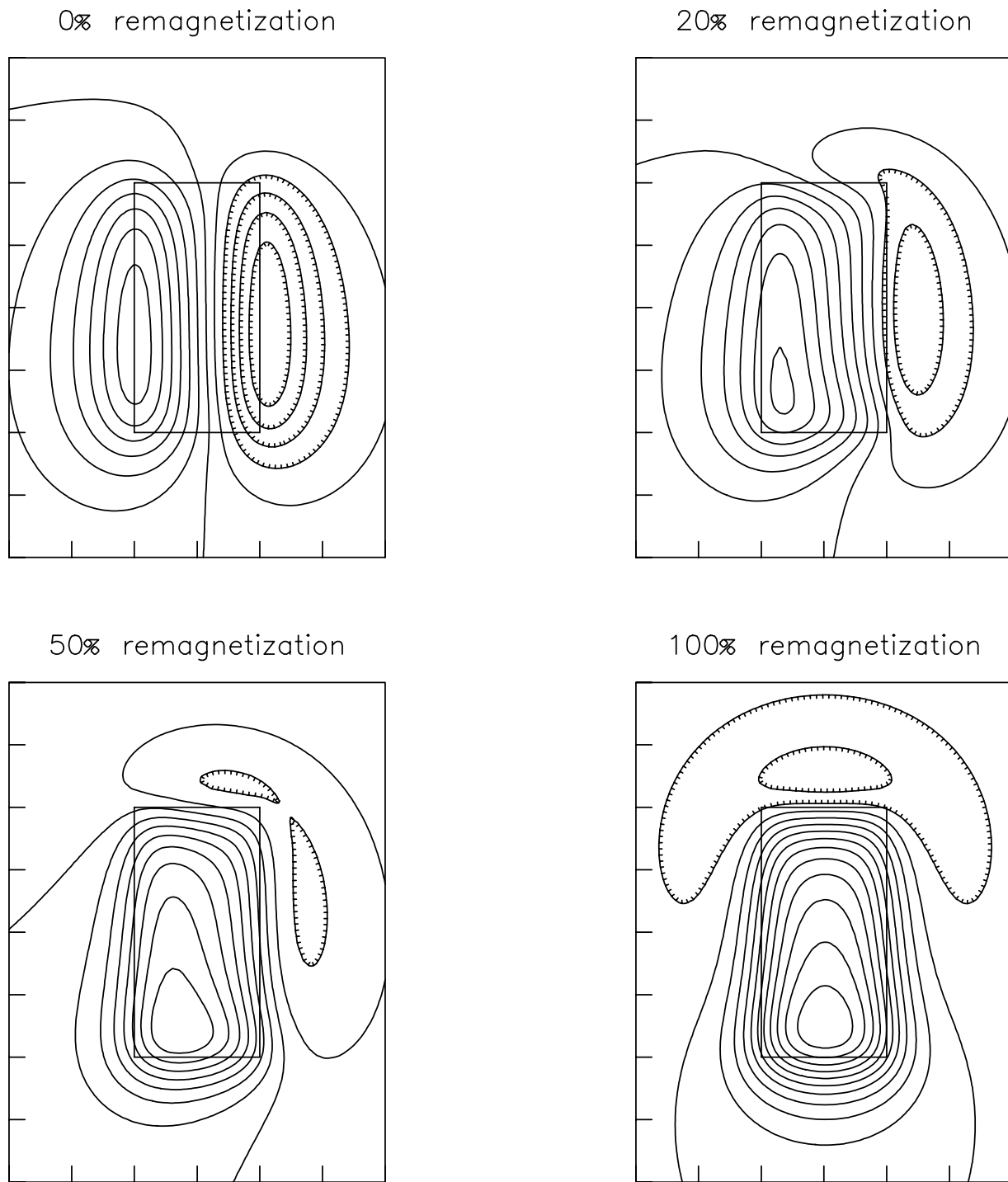
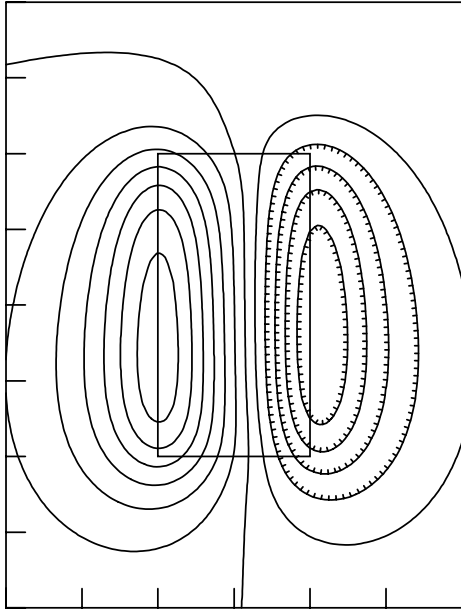
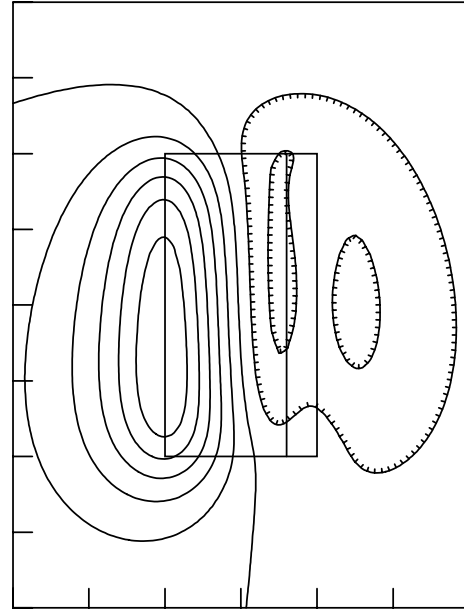

Figure 13: The effect of refiring the top of a brick. The original remanent magnetization of each brick is assumed to be toward the right, and the direction of the earth's present magnetic field is assumed to be toward the top in each map. As a greater thickness of brick is remagnetized by refiring, the magnetic low rotates from the east to the north.

0% remagnetization



20% remagnetization



50% remagnetization

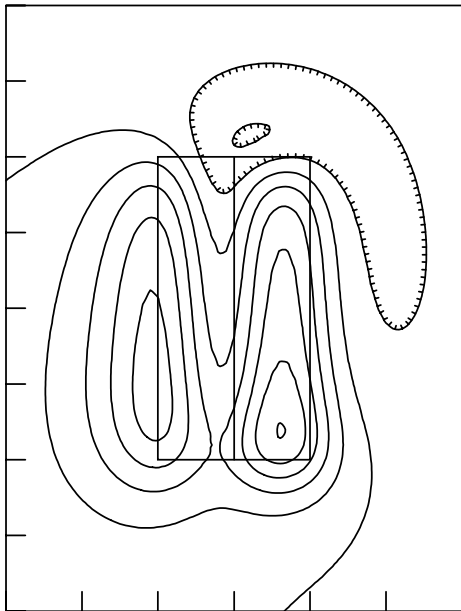

100% remagnetization

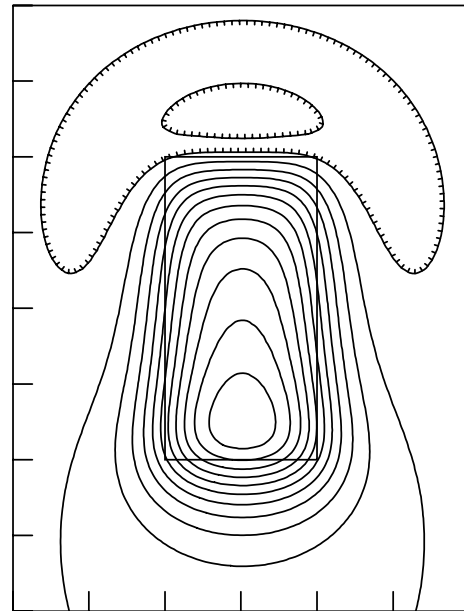

Figure 14: The effect of refiring the right-hand side of a brick. Except for this, the magnetic conditions are the same as those in [Figure 13](#). Note the complex anomaly caused by the abrupt change in magnetization across the brick; this refiring boundary is marked with a straight line along the length of the brick, shown with a rectangle.

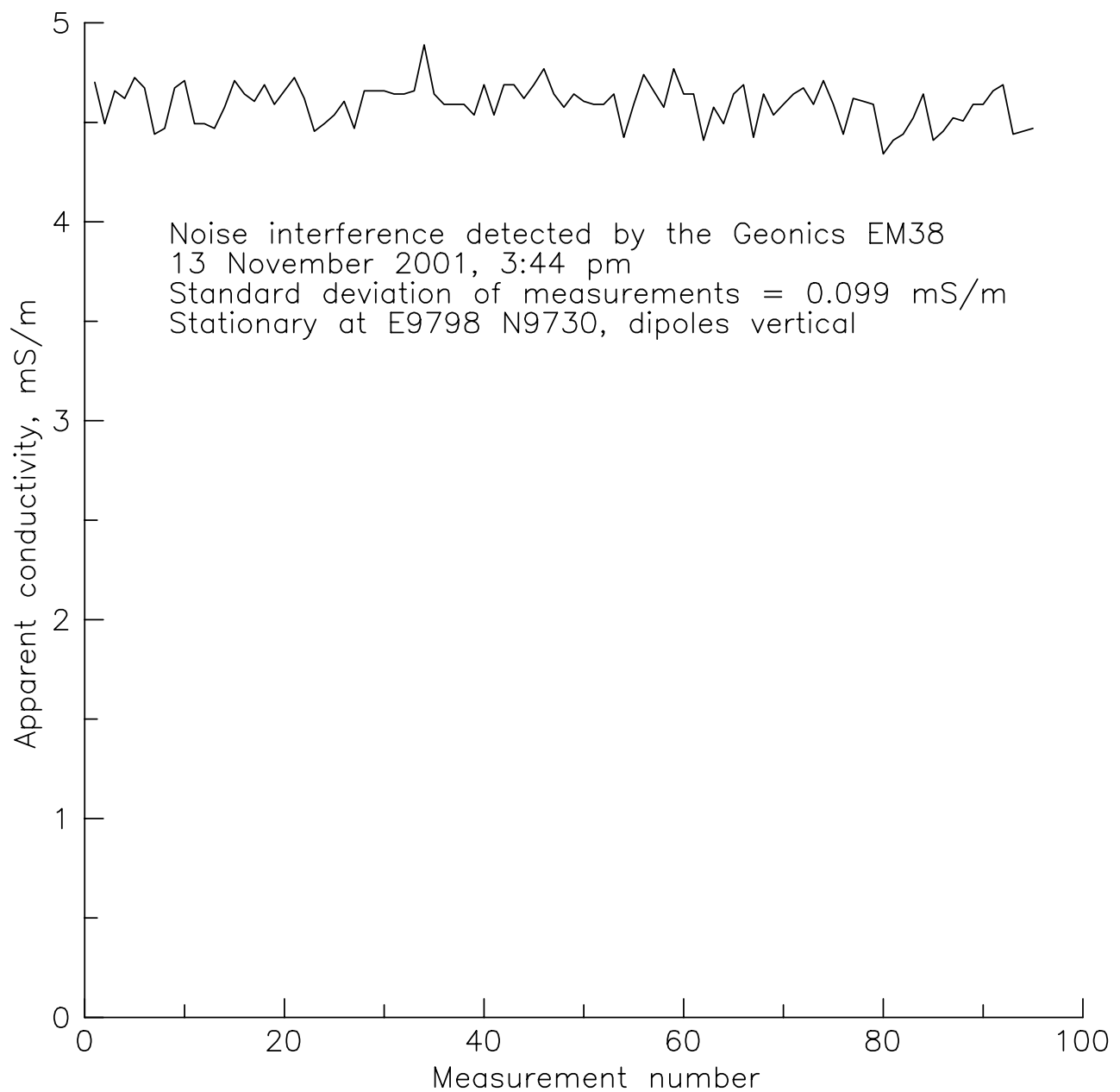

Figure 15: Electrical noise that was detected by the EM38 conductivity meter. It had no serious effect on the measurements in [Figure 3](#). The noise is higher than that found during my 1994 surveys; this may be because of the active electrical wires that are now nearby.